

Infrared Barrier User Manual

Version 4-1

1.Description

Infrared barrier is a type of active infrared detector. Using frequency conversion mutual radiation technology, once a person or object blocks the infrared beam between the transmitter and receiver (the factory default is to block two adjacent beams or more), an alarm signal will be output immediately.

2.Features

- 1). Adopt digital frequency conversion and 32-bit high-speed MCU micro-processing digital control technology to improve stability;
- 2). Using aluminum alloy shell, anti-dismantling, anti-shearing, anti-movement function design;
- 3). Support asynchronous and synchronous working modes (the factory default is synchronous working mode);
- 4). Adopting frequency conversion mutual radiation technology, 2 frequency are selectable (the factory default is frequency A), which completely solves the mutual interference between adjacent barriers and avoids direct sunlight, flashlights, and car lights.
- 5). The dual beam recognition function can effectively prevent small animals, birds, etc. from causing false alarms;
- 6). High sensitivity, 3 levels of adjustable guard distance;
- 7). Anti-interference ability: it can be used in harsh outdoor environments with wind, frost, rain, snow, fog, tide, and oblique sunlight;
- 8). Independent tamper switch, the design is more reasonable and reliable, to ensure that the barrier is not damaged by disassembly;
- 9). Support buzzer calibration prompt;

3.Technical Parameters

Warning distance: 0-100m for synchronous work, 10-80m for asynchronous work

Beam: 2/4/6/8/10/12 beams

Power supply: DC 9-30V

Current consumption: 50-120mA

Temperature: -30°C~70°C

Alarm output: NO/NC optional (factory default NC), contact capacity 30V 2A

Detection method: block two adjacent beams (single beam alarm can be set)

Alarm duration: $\geq 1S$ (instant alarm can be set)

Independent tamper output: when the shell is removed, NC output

Response time: $\leq 40ms$

Optical axis adjustment angle: horizontal 180°, vertical is non-adjustable

Other additional functions: LED indication, buzzer prompt

Material: aluminum, PC engineering plastics

4.Product diagram

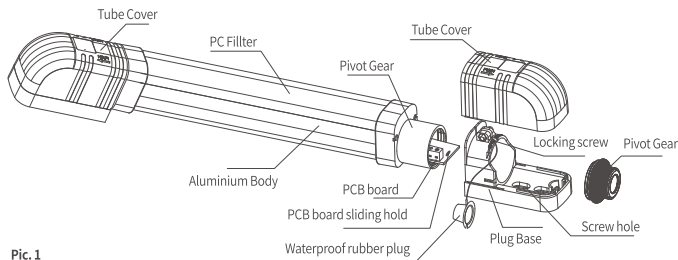

Pic. 1

5.Installation and Instructions

1.If you need to set the alarm output state or alarm mode of the barrier,Gently shake the tube cover left and right, and pull the "receiver" out of the tube plug to prevent the circuit board from being broken by excessive force, and then pull out the main board of the receiver PCB, after setting, push it back (Picture 2)

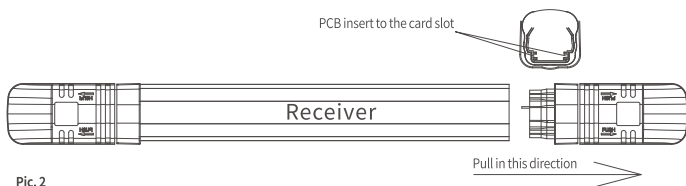

Pic. 2

2).Pull the tube cover in pointed direction(Pic. 3)

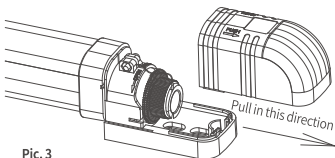

Pic. 3

3).Drill holes on the wall with a 6mm drill bit, insert the expansion rubber plug, and then fix the upper and lower mounting bottom seats with M4*25 self tapping screws(Pic.4)

Note:

1.The transmitter (abbr TX) and receiver (abbr RX) of infrared barrier needs to be installed on the same horizontal level and vertically to the ground.

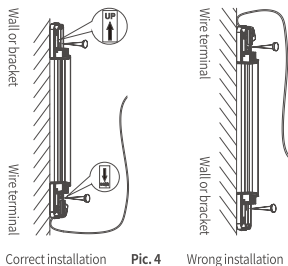

Pic. 4

Wrong installation

2.The wire terminals must be at the bottom of the beams,else rain will enter and damage PC-board.

- 4).Open waterproof rubber plug as Pic.5
- 5).Remove the seal cover plug by rotating it counter clockwise as in Pic.6
- 6).Insert the screwdriver into the push-pull hole of the PCB board,then set it as Pic.7

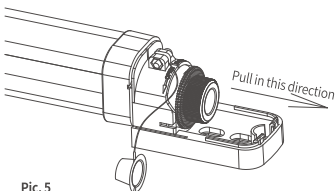

Pic. 5

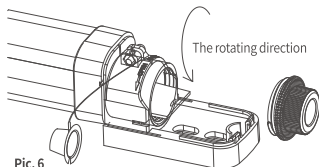

Pic. 6

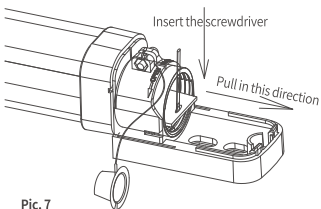

Pic. 7

7).Function setting

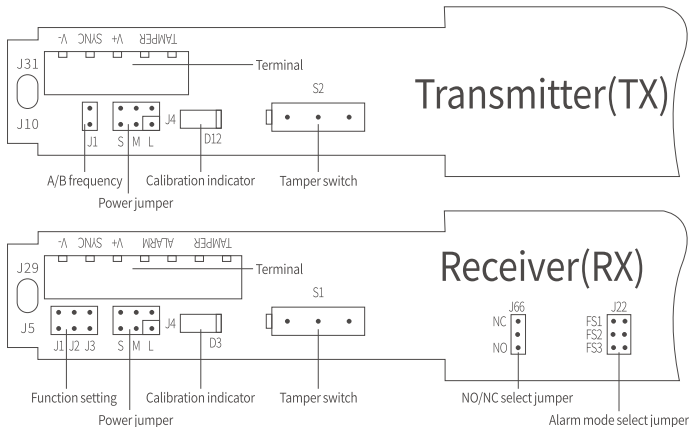

Transmitter

J10	J1	Jumper ON-Frequency A(make sure RX is the same)
		Jumper OFF-Frequency B(make sure RX is the same)
J4	L	Jumper ON-High transmitter power
	M	Jumper ON-Medium transmit power
	S	Jumper ON-Low transmit power
		Jumper OFF ALL-Very Low Power

Receiver

J5	J1	Jumper ON-Frequency A(make sure TX is the same)
		Jumper OFF-Frequency B(make sure TX is the same)
	J2	Jumper ON-Synchronization cable NOT used(only when less than 3 pairs installation in a same line or plane)
		Jumper OFF-Synchronization cable used
	J3	Jumper ON-Receiver buzzer sound
		Jumper OFF-Receiver buzzer Not sound
J4	L	Jumper ON-High transmitter power
	M	Jumper ON-Medium transmit power
	S	Jumper ON-Low transmit power
		Jumper OFF ALL-Very Low Power
J66	NC	Jumper on NC-NC output
	NO	Jumper on NO-NO output
J22	J22 is empty by default, special functions refer to FS1, FS2, FS3	
	FS1	Jumper ON-2 beams instant alarm mode,0.1s to recover
	FS2	Jumper ON-1 beam alarm mode,2s to recover
	FS3	Jumper ON-1 beam instant alarm mode,0.1s to recover

8).Cable passes through the central bore of the sealing cap

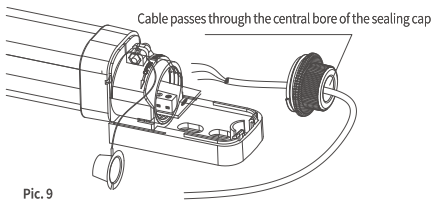

Pic.9

9).Wiring method

Single power supply, sync working mode wiring diagram

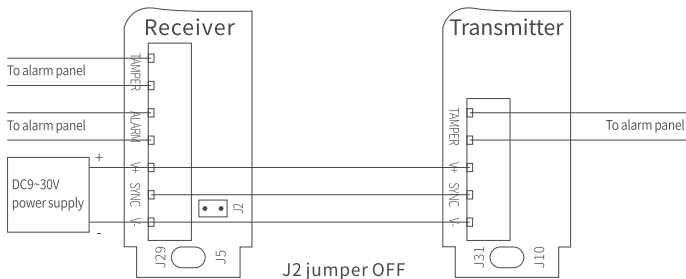

Dual power supply, sync working mode wiring diagram

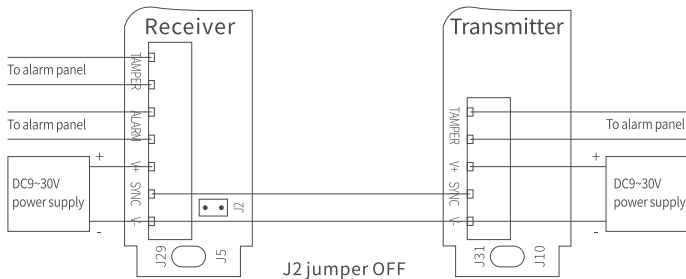

Dual power supply, async working mode wiring diagram

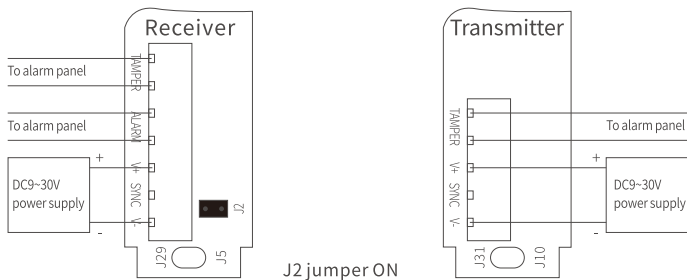

Sync\Async working notes:

Async working only be used when less than 3 pairs installation in a same line or plane,if more than 3 pairs,the sync working is necessary.

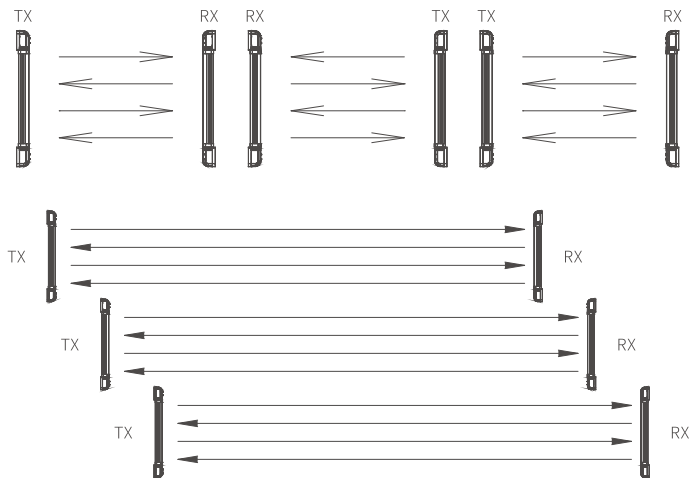

10). Adjust the position of RX & TX, make sure both are at the same horizontal level, and at the same vertical level facing each other laterally;

Adjust RX & TX left or right till buzzer sounds, find critical direction (refer to Pic.10)

Adjust both RX & TX out the critical directions area either left or right.

Alarm buzzer should not sound.

Alignment complete.

11). Seal the unit correctly and wires at the bottom to prevent water damage.

12). Block adjacent 2 beams, alarm triggers, buzzer rings, indicator lights, alarm output turns from NC to NO.

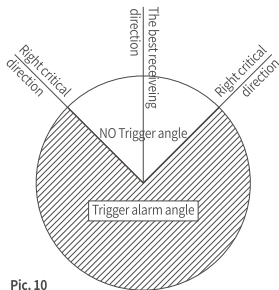

Pic. 10

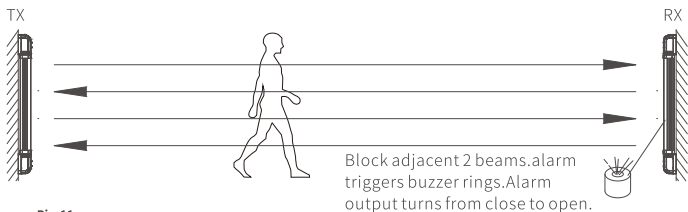

Pic. 11

6. Troubleshooting

1). LED on TX & RX are always on, buzzer keeps sounding when trying to align:

A. Check if TX & RX are set to same frequency (J1)

B. Check the voltage of TX & RX, make sure that all connections are correct and tightly.

C. Check if J3 is inserted on TX & RX.

D. Make sure that the distance between TX and RX are within the detection range.

E. Make sure there is no obstacles between TX & RX.

2). LED on RX flashed, LED of TX is off and buzzer gives short beeps when busy with alignment (this is a warning condition)

A. Check voltage on TX

B. Obstruct each beam on TX, make sure when blocking beam that buzzer beeps. If buzzer beeps continuously, alignment was successful.

3). Alarm sensitivity is very slow even though a beam is blocked.

A. Check whether already block adjacent 2 beams.

B. Check for reflective objects and surfaces.

C.Adjust jumper J4 to a lower and then low power setting and see if it improves.

4).Alarm output relay.

A.Block beam and make sure buzzer beeps when blocking beam on RX.

B.Check continuity on alarm output relay.

C.Make sure the cable going to alarm panel is not damaged.

D.Make sure that the TX and RX are not beyond the detection range,make sure power is correct and the same on both RX and TX.

E.Check the alarm panel programming.