

JA-150ST Wireless combined smoke and heat detector

The JA-150ST is a component of the JABLOTRON JA-100 system. It is used to detect fire hazards in a building interior. The product is not designed to be installed in industrial premises. The detector is powered by three LR6 (AA) type alkaline batteries, which are not included. We recommend you buy them together with the detector. The JA-150ST consists of an optical smoke detector and a heat detector. The optical smoke detector is very sensitive to large dust particles which are present in dense smoke. It is less sensitive to smaller particles generated by the combustion of liquids such as alcohol. That is why the fire detector also contains a built-in heat detector which has a slower reaction but is much better at detecting fire which generates only a small amount of smoke. The detector has a status reaction (reports its activation and deactivation). The detector should be installed by a trained technician with a valid certificate issued by an authorized distributor.

Detector location

The smoke detector must be installed so that any smoke easily drifts into the detector owing to natural thermal circulation (usually on the ceiling). The detector can be used only in closed interiors. It is not suitable for interiors where smoke can disperse over a large area and cool down (e.g. interiors with extremely high ceilings – above 5 m) – the smoke would not reach the detector position.

The detector must be always placed in the section leading to the exit of the building (escape route), see Figure 1. If the building has a floor area greater than 150 m², installation of an additional detector in some other suitable place is required, see Fig.2.

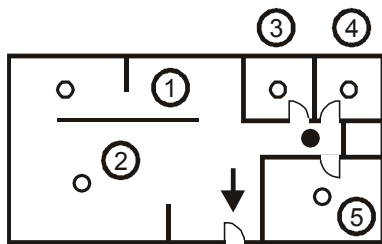

Fig 1

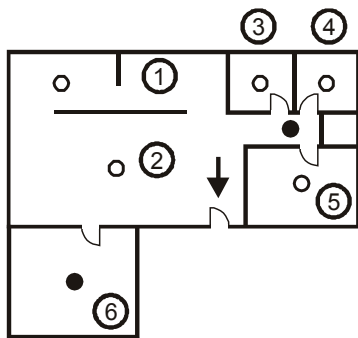

Fig 2

1. kitchen,
 2. living room,
 3. – 6. bedrooms
- / ■ basic coverage
○ recommended coverage

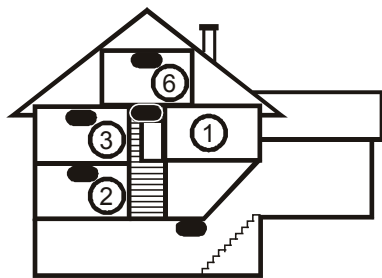

Fig 3

In buildings and family houses with multiple floors, detectors should be installed above stairwells. It is recommended to place additional detectors in rooms where people sleep. See fig 3.

Installation on level ceilings

Place the detector in the centre of the room if possible. **The detector must not be recessed into the ceiling** due to the possible existence of a warm air layer on the ceiling. **Never place the detector in the corner of the room** (always keep at least 0.5 m distance from the

corner) see Fig 4. There is an insufficient circulation of air in the corners.

Installation on sloping ceilings

If the ceiling is not suitable for mounting on a level surface (e.g. a room under a roof ridge), then the detector can be installed as in Fig 5.

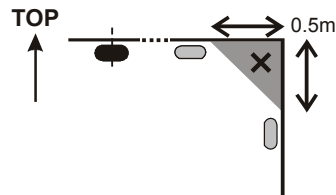

Fig 4

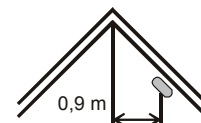

Fig 5

- centre of the room, best location
- acceptable location

Walls, partitions, barriers and lattice ceilings

The JA-150ST detector must not be installed closer than 0.5 m from any wall or partition. A narrow space with a width of less than 1.2 m requires the detectors to be placed at a distance of at least one third of its width away. If a room is separated into sections with furniture, racks or semi partition walls, which do not reach the ceiling, the space is considered to be fully separated if the gap between the top of these and the ceiling does not exceed 0.3 m. A free space of at least 0.5m is required under and around the detector. Any irregularities of the ceiling (e.g. girders) exceeding 5% of the ceiling height should be considered a wall and the above-mentioned limitations should apply.

Ventilation and air circulation

The detectors must not be installed directly by ventilation or air conditioning vents, etc... If the air is supplied through a perforated ceiling, there must be no perforation within a radius of 0.6 m of the detector.

Avoid installing the detector in the following locations:

- Places with poor air circulation (niches, corners, apexes of A-shaped roofs, etc.)
- places exposed to dust, cigarette smoke or steam
- Places with over-intense air circulation (close to ventilators, heat sources, air conditioning outlets, etc.)
- In kitchens and other cooking places (because steam, smoke or oily fumes can reduce detector sensitivity, thus cause false alarms and detection faults).
- Within a 1m radius of fluorescent tubes or energy-saving light bulbs (electrical interference may negatively affect the detector's radio communication)
- In areas with lots of small insects

Warning: The most false alarms are caused by an improper location of the detector.

See CEN/TS 54-14 standards for detailed installation guidelines.

Installation

Abide by the procedures recommended in the previous paragraphs.

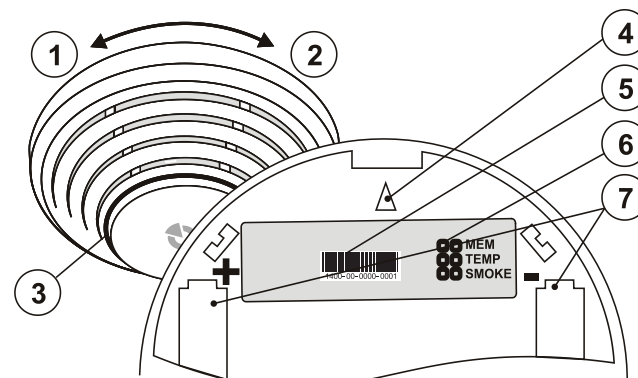

Fig 6: 1 – detector cover opening; 2 – detector cover closing; 3 – optical status signalling; 4 – arrow showing where to insert the detector onto the bottom part; 5 – production code; 6 – configuration jumpers; 7 – battery holders

JA-150ST Wireless combined smoke and heat detector

Instructions:

- Open the detector cover, by turning it anti-clockwise (1).
- Attach the removed plastic base to the desired place with screws.
- Set the configuration jumpers (6) according to the table below.
- Proceed according to the control panel installation manual. Basic procedure:
 - Go to the **F-Link** program, select the required position in the **Devices** window and launch **Enrollment mode** by clicking on the **Enroll** option.
 - Insert all batteries into the detector, an enrollment code is sent to the system – sending is confirmed with a short flash of the LED indicator (3).
- Insert the detector into the plastic base. The detector can be inserted into the plastic base only in one position, which is marked with arrows (4) on both plastic parts, provided that all three batteries are inserted. Close the detector cover by turning it clockwise (2). When the detector is fully secured to the base, a control LED lights up (3), which indicates an automatic detector test. During this period of time, the detector doesn't detect anything. The test ends when the LED shuts down (3), the detector becomes fully operational. A possible detector fault may be indicated, see the **Fault indication** chapter.

Note:

The detector can also be enrolled into the system by entering its serial number (5) in the F-Link program or on a keypad (or using a bar code scanner). All numbers stated under the bar code shall be entered (1400-00-0000-0001).

Detector settings

The detector properties can be set with configuration jumpers.

| | | | | | |
|--|-----|-----------------|---|-----|----------------------------------|
| 1 | ON | Memory disabled | 2 | OFF | Smoke(EN 54-7) or heat (EN 54-5) |
| | OFF | Memory enabled | 3 | OFF | |
|  | 2 | OFF | Smoke only (EN 54-7), (not heat) | | |
| | | 3 | ON | | |
| | 2 | ON | Heat only (EN 54-5) (not smoke) | | |
| | | 3 | OFF | | |
| | 2 | ON | Smoke and heat (both conditions at the same time) | | |
| | | 3 | ON | | |

Jumper 1 MEM - Signalling the alarm memory. The signalling LED remains active for 24 hours after the reason for the alarm ceases to exist.

Jumper 2 and 3 TEMP and SMOKE - The combination of these configuration jumpers defines how the detector will react to smoke and heat.

It's possible to change the system's reaction to something other than Fire using the **F-Link** program. This setting is in the **Reaction** options in the **Devices** window.

Warning: This device cannot be considered a fire detector when it's configured to a different reaction. Upon detector activation, the system signals accordingly to the settings of the control panel. The detector will always signal activation by smoke or heat with a quickly flashing red LED regardless of the configured reaction and the control panel status (set/unset/service).

Fire alarm

Optical detector: When smoke enters the detector, an alarm is triggered, and it is signalled with a rapidly flashing red LED light (approx. 8 times per second). The indication lasts until the room is ventilated (thus also ventilating the detector's detection chamber).

Heat detector: When the temperature rises above a set limit, an alarm is triggered, and it is signalled with a rapidly flashing red LED (approx. 8 times per second). The indication lasts until the temperature drops (e.g. when the room is ventilated).

Alarm memory: If enabled, **LED alarm indication** continues flashing slowly (approx. 4 times per second) for a further 24 hours after the alarm stops. The indication can be terminated by opening the detector cover by turning it anti-clockwise and activating the tamper sensor. **WARNING!** The control panel must be switched to Service mode otherwise a Tamper alarm will be triggered.

Tamper alarm: When the detector cover is opened, the tamper alarm is activated unless the control panel is in Service mode.

Detector testing and maintenance

Functionality of the optical part of the detector can be tested with a test spray for smoke detectors. The functionality of the heat part can be tested with a hairdryer. If the detector is configured to both conditions, it's necessary to conduct both spray and hairdryer tests at the same time. The test should be carried out once in 30 days. The detector's cover should be cleaned regularly from cobwebs and dust. No additional maintenance is necessary.

Warning: never test the detector with fire inside the building.

Battery replacement

The system sends a report automatically when the battery is low. Optical indication then flashes briefly once every 30 seconds. Remember to switch the system to Service mode before changing the batteries otherwise a tamper alarm will be triggered. It is always essential to replace all three batteries. Use the same type and the same brand for all of them. Wait for 90 seconds in order to let the detector's circuitry discharge before inserting new batteries.

Fault indication

The detector checks its functionality. When a fault is detected, LED indication immediately flashed 3 times and then briefly 3 times every 30 seconds (a failure of the automatic functionality test is signaled the same way, see the **Installation** chapter). The error found may be caused by a fault of the detection chamber, the temperature of the environment being out of the operating temperature range or other faults of the detector.

An operating temperature range fault will disappear the moment the temperature of the environment turns back to normal.

Other faults found are indicated as a fault even after their cause has gone. The fault indication can be stopped by the functionality test. The functionality test is triggered by opening the detector cover (fig 6-1), removing the lower plastic part and putting it back (fig 6-2). If this test results in a fault, send the detector to the repair service.

WARNING! The control panel must be switched to Service mode otherwise a Tamper alarm will be triggered.

The detector will alert you in case of low batteries by an LED flashing once every 30 seconds.

Technical specifications

| | |
|------------------------------|---|
| Power | 3x LR6 (AA) type alkaline batteries, 1.5 V Warning: batteries are not included |
| Typical battery lifetime | approx. 3 years |
| Communication band | 868.1 MHz, Jablotron protocol |
| Communication range | approx. 300 m (unrestricted area) |
| Dimensions | diameter 126 mm, height 50 mm |
| Weight | 142 g (without batteries) |
| Smoke detection | optical light scattering |
| Smoke detector sensitivity | m = 0.11 - 0.13 dB/m pursuant to EN 54-7 |
| Heat detection | class A2 according to EN 54-5 |
| Alarm temperature | +60 °C to +70 °C |
| Operating temperature range | -10 °C to +80 °C |
| Complies with | EN 54-5, EN 54-7, EN 54-25 |
| Also complies with | ETSI EN 300220, EN 50130-4 EN 55022, EN 60950-1 |
| Can be operated according to | ERC REC 70-03 |



JABLOTRON ALARMS a.s. hereby declares that the JA-150ST is in a compliance with the relevant Union harmonisation legislation: Directives No: 2014/53/EU, 2014/35/EU, 2014/30/EU, 2011/65/EU. The original of the conformity assessment can be found at www.jablotron.com - Section Downloads.



Note: Although this product does not contain any harmful materials we suggest you return the product to the dealer or directly to the producer after use.